

MC561 Pluggable PCB Connector, Plug with Flanges

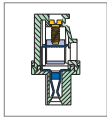

DIMENSIONS/POSITIONS

	MC561-350	MC561-381
Pitch	3.50mm	3.81mm
Poles	2 ~ 24Poles	2 ~ 20Poles
Dimension A	3.50mm	3.81mm
Length	A= 3.50xP+10.40mm(P≥2)	A= 3.81xP+10.40mm(P≥2)
Housing Material	PA 66	PA 66
Cage Clamp	Brass, Ni Plated	Brass, Ni Plated
Contact	Phosphor Bronze, Tin Plated	Phosphor Bronze, Tin Plated
Screw Thread	M2.0, Steel, Ni Plated	M2.0, Steel, Ni Plated
Wire Size	16 ~ 24AWG	16 ~ 24AWG
Tightening Torque, Max.	3.0 Lb-in	3.0 Lb-in
Operating Temperature	-40°C to +105°C	-40°C to +105°C

TECHNICAL DATA

Connection in acc. with standard EN-VDE		
Nominal Current I _N	8A	8A
Nominal Cross Section	1.5mm ²	1.5mm ²
Maximum load current	8A	8A
Insulating Material	PA	PA
Inflammability class acc. to UL94	V0	V0
Nominal voltage, UL/CUL	300V	300V
Nominal current, UL/CUL	8A	10A

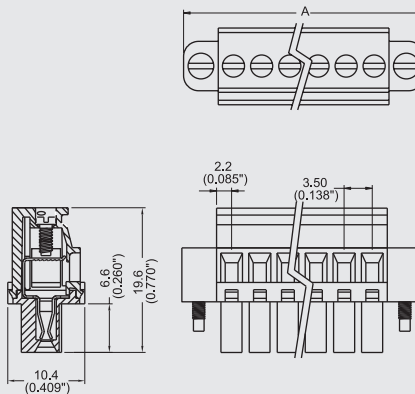

Note:
Screw Plating: Changes are available upon request

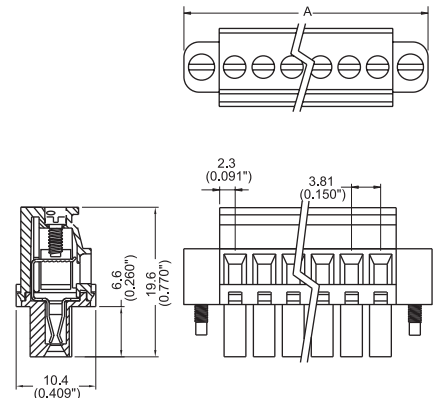

Note:
Screw Plating: Changes are available upon request