

ME240 Male Connector, Double Level Header

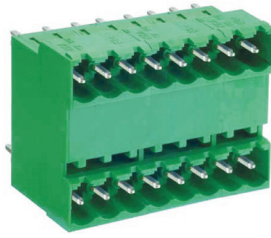
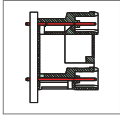

DIMENSIONS/POSITIONS

ME240-508

Pitch	5.08mm
Poles	4 ~ 48Poles
Dimension A	5.08mm
Length	A= 5.08xP/2+1.20mm(P≥4)
Housing Material	PA 66
Pin Dimensions	Brass, Tin Plated
PCB Hole Diameter	1.5mm
Operating Temperature	-40°C to +105°C

TECHNICAL DATA

Connection in acc. with standard EN-VDE	
Nominal Current I _N	12A
Nominal Cross Section	-
Maximum load current	12A
Insulating Material	PA
Inflammability class acc. to UL94	V0
Nominal voltage, UL/CUL	300V
Nominal current, UL/CUL	16A

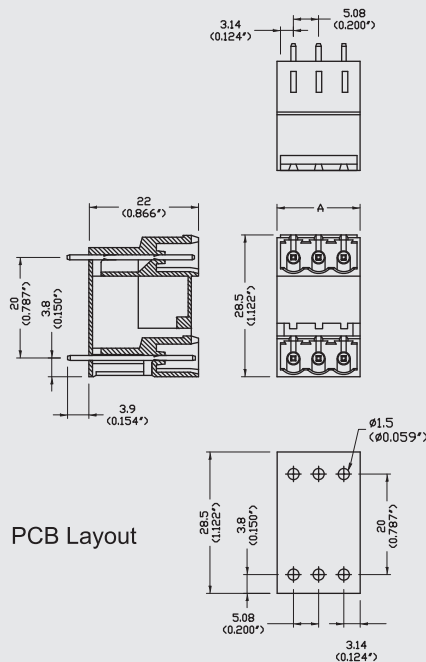

PCB Layout